

Mega pump

Features and Strengths

Highly operational reliability despite fluctuating or low compressed-air pressure
The largest compressed-air driven vacuum pump with comparatively compact and light weight

Advantages

Excellent performance in application that the large vacuum flow is needed such as replacement with Motor pump or conveyor system
Reliable and stable operation - High vacuum level and vacuum flow in efficient air consumption
Optional Air-saving kit (AS-KIT) to minimize energy consumption

Application

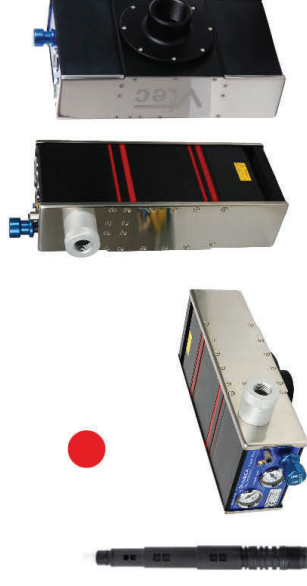
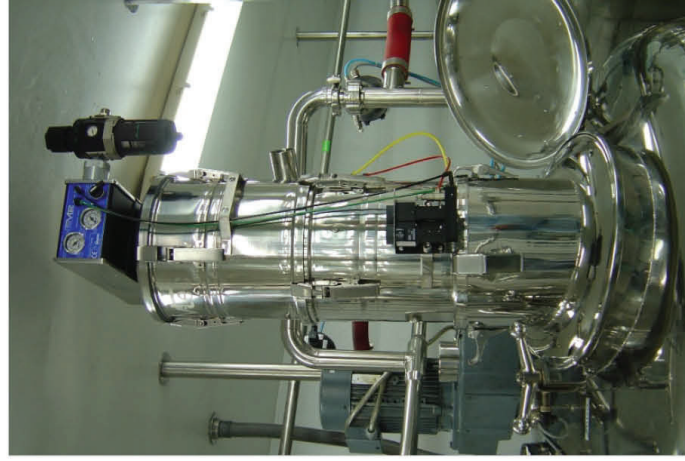

Overall of specification

Model	Max. Vacuum level (- kPa)	Max. Feed Pressure (bar)	Max. Vacuum Flow (NI/m)	Air Consumption (NI/m)
ML200	92	7	2410	600 ~ 780
ML400	92	7	4820	1200 ~ 1680
ML600	92	7	7230	1800 ~ 2520
ML800	92	7	9640	2400 ~ 3360
ML1000	92	7	12050	3000 ~ 4140
ML1200	92	7	14460	3600 ~ 4920
VCML100	92	7	1364	608
VCML200	92	7	2728	1072
VCML400	92	7	5456	2144
VCML100L	75	7	1448	416
VCML200L	75	7	2896	832
VCML400L	75	7	5792	1664

Mega pump

VMECA Mega pump is the biggest vacuum pump in the range to be used in large vacuum flow needed vacuum conveyor or replacement with large motor pump.
With air saving kit, air consumption can be dramatically reduced while covering the application which needs high vacuum flow.



- VMECA vacuum cartridge integrated
- High vacuum flow to replace up to 12kw motor pump
- Energy save by air saving kit

Exhaust port

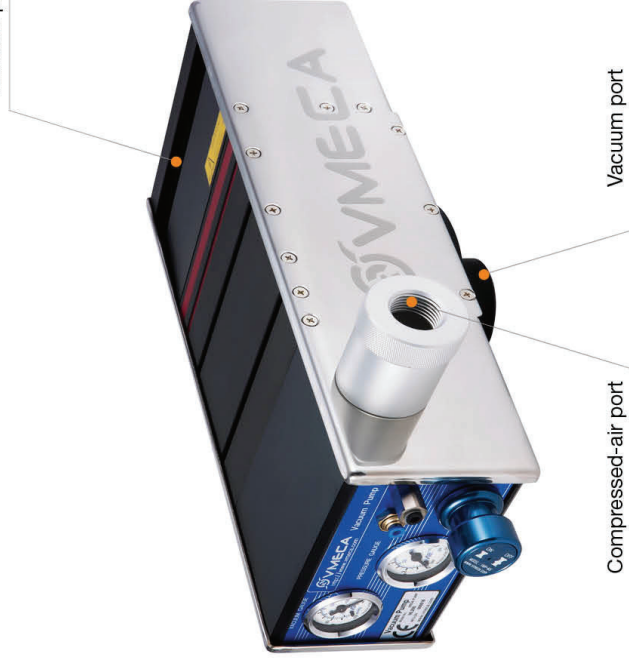

Vacuum port

Compressed-air port

External Exhaust Port

Basically, external exhaust port is used in the purpose to prevent exhaust air for elaborate work or which is clean room such as semicon, food, and chemical application, etc.

With VMECA conveyor system, an external exhaust port is used when the particles are too small for the filter to catch. When this happens, the small particles will exit through the exhaust port. For this reason the external exhaust port has been created to either recycle the particles back into the conveyor system or dump it in a container.

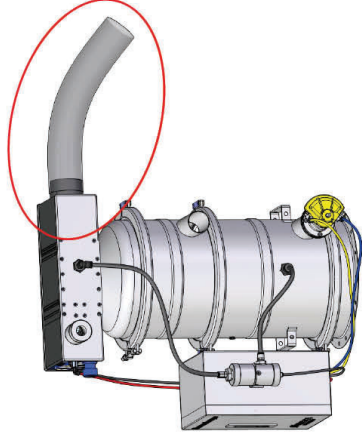

Example

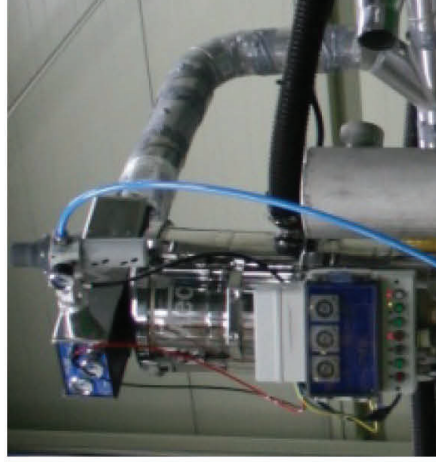
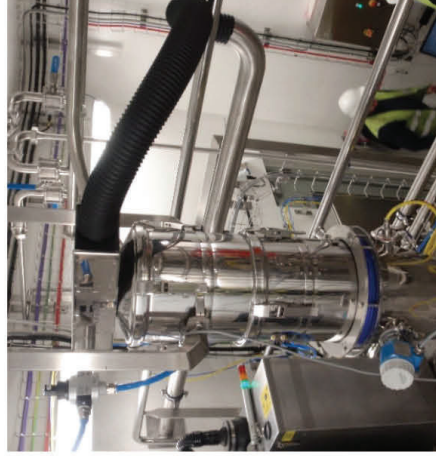

ML200

Features and Strengths

- High vacuum flow to replace motor pump
- Easy maintenance
- Excellent performance in leakage application and in conveying system for granules, transferring bulk materials and powder

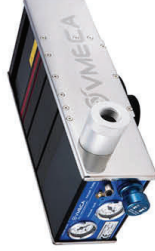

Specifications

Description	ML200
Max. Vacuum level	-92 kPa
Open Vacuum flow	2410 NI/min
Max. Feed pressure	7 bar
Temperature	-20 ~ 80 °C
Noise level	68 ~ 76 dBA
Weight	4,800 g

Vacuum Flow

Model	Max. vacuum (-kPa)	Feed Pressure (bar)	Vacuum flow (NI/min) at different vacuum levels (-kPa)									
			0	10	20	30	40	50	60	70	80	90
ML200	92	6.0	2410	1688	1116	580	290	216	144	80	40	6.4

Evacuation Time

Model	Feed Pressure (bar)	Air Consumption (NI/min)	Evacuation time in sec / liter to reach different vacuum levels (-kPa)								
			10	20	30	40	50	60	70	80	90
ML200	6.0	600 ~ 780	0.0021	0.0055	0.0124	0.029	0.054	0.09	0.153	0.274	0.67

ML400

Features and Strengths

- High vacuum flow to replace motor pump
- Easy maintenance
- Excellent performance in leakage application and in conveying system for granules, transferring bulk materials and powder



Specifications

Description	ML400
Max. Vacuum level	-92 kPa
Open Vacuum flow	4820 NI/min
Max. Feed pressure	7 bar
Temperature	-20 ~ 80 °C
Noise level	68 ~ 76 dBA
Weight	4,800 g

Vacuum Flow

Model	Max. vacuum (-kPa)	Feed Pressure (bar)	Vacuum flow (NI/min) at different vacuum levels (-kPa)									
			0	10	20	30	40	50	60	70	80	90
ML400	92	6.0	4820	3376	2232	1160	580	432	288	160	80	12.8

Evacuation Time

Model	Feed Pressure (bar)	Air Consumption (NI/min)	Evacuation time in sec / liter to reach different vacuum levels (-kPa)								
			10	20	30	40	50	60	70	80	90
ML400	6.0	1200 ~ 1680	0.0011	0.0027	0.0062	0.014	0.027	0.045	0.076	0.137	0.335

Dimensions – Basic Pump

ML200 & 400

[Unit : mm]

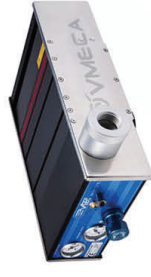

Features and Strengths

- High vacuum flow to replace motor pump
- Easy maintenance
- Excellent performance in leakage application and in conveying system for granules, transferring bulk materials and powder

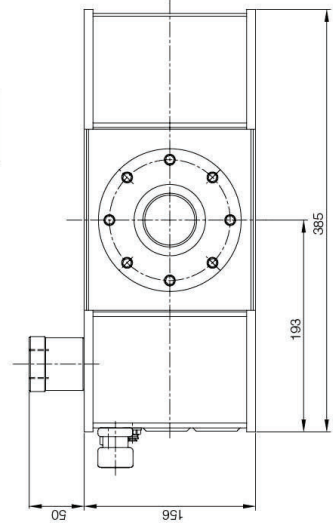
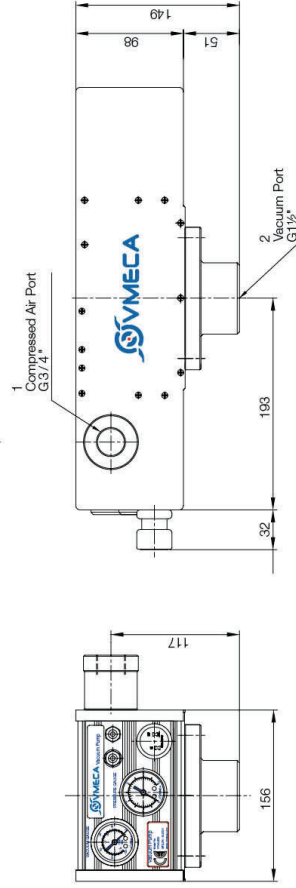
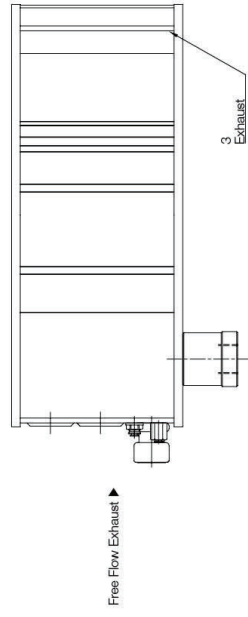
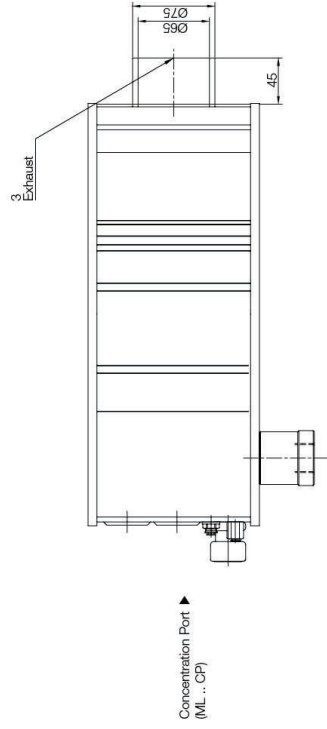

Specifications

Description	ML600
Max. Vacuum level	-92 kPa
Open Vacuum flow	7230 NI/min
Max. Feed pressure	7 bar
Temperature	-20 ~ 80 °C
Noise level	68 ~ 76 dBA
Weight	5,920 g

Vacuum Flow

Model	Max. vacuum (-kPa)	Feed Pressure (bar)	Vacuum flow (NI/min) at different vacuum levels (-kPa)									
			0	10	20	30	40	50	60	70	80	90
ML600	92	6.0	7230	5064	3348	1740	870	648	432	240	120	19.2

Evacuation Time

Model	Feed Pressure (bar)	Air Consumption (NI/min)	Evacuation time in sec / liter to reach different vacuum levels (-kPa)								
			10	20	30	40	50	60	70	80	90
ML600	6.0	1800 ~ 2520	0.0009	0.0021	0.0047	0.011	0.021	0.034	0.057	0.103	0.252

ML800

Features and Strengths

- High vacuum flow to replace motor pump
- Easy maintenance
- Excellent performance in leakage application and in conveying system for granules, transferring bulk materials and powder



Specifications

Description	ML800
Max. Vacuum level	-92 kPa
Open Vacuum flow	9640 NI/min
Max. Feed pressure	7 bar
Temperature	-20 ~ 80 °C
Noise level	68 ~ 76 dBA
Weight	6,080 g

Vacuum Flow

Model	Max. vacuum (-kPa)	Feed Pressure (bar)	Vacuum flow (NI/min) at different vacuum levels (-kPa)									
			0	10	20	30	40	50	60	70	80	90
ML800	92	6.0	9640	6752	4464	2920	1160	864	576	320	160	25.6

Evacuation Time

Model	Feed Pressure (bar)	Air Consumption (NI/min)	Evacuation time in sec / liter to reach different vacuum levels (-kPa)								
			10	20	30	40	50	60	70	80	90
ML800	6.0	2400 ~ 3360	0.0006	0.0014	0.0031	0.007	0.014	0.023	0.038	0.068	0.168

ML1000

Features and Strengths

- High vacuum flow to replace motor pump
- Easy maintenance
- Excellent performance in leakage application and in conveying system for granules, transferring bulk materials and powder



Specifications

Description	ML1000
Max. Vacuum level	-92 kPa
Open Vacuum flow	12050 NI/min
Max. Feed pressure	7 bar
Temperature	-20 ~ 80 °C
Noise level	68 ~ 76 dBA
Weight	7,700 g

Vacuum Flow

Model	Max. vacuum (-kPa)	Feed Pressure (bar)	Vacuum flow (NI/min) at different vacuum levels (-kPa)									
			0	10	20	30	40	50	60	70	80	90
ML1000	92	6.0	12050	8440	5580	2900	1450	1080	720	400	200	32

Evacuation Time

Model	Feed Pressure (bar)	Air Consumption (NI/min)	Evacuation time in sec / liter to reach different vacuum levels (-kPa)								
			10	20	30	40	50	60	70	80	90
ML1000	6.0	3000 ~ 4140	0.0005	0.0012	0.0026	0.006	0.012	0.018	0.031	0.057	0.147

ML1200

Features and Strengths

- High vacuum flow to replace motor pump
- Easy maintenance
- Excellent performance in leakage application and in conveying system for granules, transferring bulk materials and powder

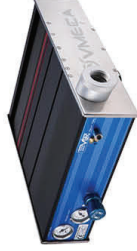

Specifications

Description	ML1200
Max. Vacuum level	-92 kPa
Open Vacuum flow	14460 NI/min
Max. Feed pressure	7 bar
Temperature	-20 ~ 80 °C
Noise level	68 ~ 76 dBA
Weight	10,200 g

Vacuum Flow

Model	Max. vacuum (-kPa)	Feed Pressure (bar)	Vacuum flow (NI/min) at different vacuum levels (-kPa)									
			0	10	20	30	40	50	60	70	80	90
ML1200	92	6.0	14460	10128	6696	3480	1740	1296	864	480	240	38.4

Evacuation Time

Model	Feed Pressure (bar)	Air Consumption (NI/min)	Evacuation time in sec / liter to reach different vacuum levels (-kPa)								
			10	20	30	40	50	60	70	80	90
ML1200	6.0	3600 ~ 4920	0.0004	0.0009	0.0021	0.005	0.009	0.014	0.024	0.045	0.125

Dimensions – Basic Pump

[Unit : mm]

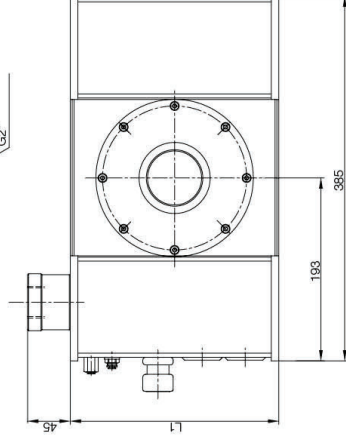
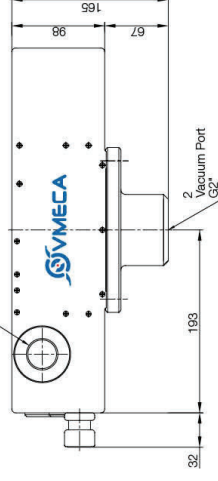
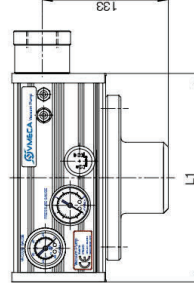
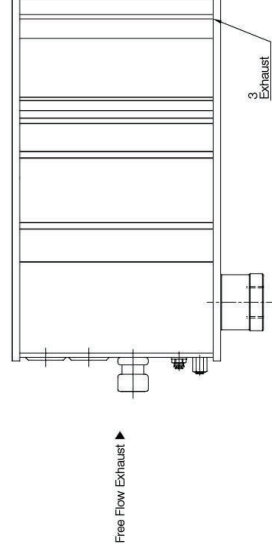
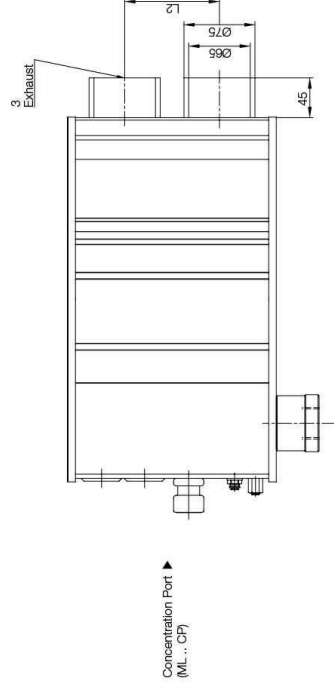

Model	L1	L2
ML600	220	100
ML800	284	160
ML1000	348	180
ML1200	412	200

Build an Ordering No.

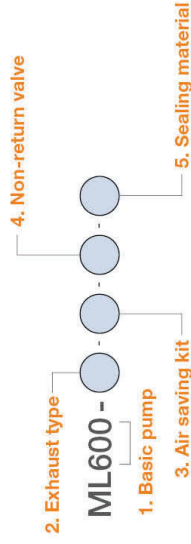

1. Basic pump	Description	Symbol
	Mega Pump - 200 Series, G1-1/2" vacuum port, G3/4" air supply port	ML200
	Mega Pump - 400 Series, G1-1/2" vacuum port, G3/4" air supply port	ML400
	Mega Pump - 600 Series, G2" vacuum port, G3/4" air supply port	ML600
	Mega Pump - 800 Series, G2" vacuum port, G3/4" air supply port	ML800
	Mega Pump - 1000 Series, G2" vacuum port, G3/4" air supply port	ML1000
	Mega Pump - 1200 Series, G2" vacuum port, G3/4" air supply port	ML1200
2. Exhaust type	Description	Symbol
	Free flow exhaust duct	Blank
	Concentration port	CP
3. Air saving kit	Description	Symbol
	No air saving kit	Blank
	Air saving kit without air control valve	AS
4. Non-return valve	Description	Symbol
	No non-return valve	Blank
	Non-return valve: No need with Air saving kit	N
5. Sealing material	Description	Symbol
	NBR	Blank
	VITON	V
	EPDM	E

Spare Parts – Basic pumps

Part No.	Description	Weight (g)
ML200	Mega Pump - 200 Series, G1-1/2" vacuum port, G3/4" air supply port	4,800
ML400	Mega Pump - 400 Series, G1-1/2" vacuum port, G3/4" air supply port	4,880
ML600	Mega Pump - 600 Series, G2" vacuum port, G3/4" air supply port	5,920
ML800	Mega Pump - 800 Series, G2" vacuum port, G3/4" air supply port	6,080
ML1000	Mega Pump - 1000 Series, G2" vacuum port, G3/4" air supply port	7,700
ML1200	Mega Pump - 1200 Series, G2" vacuum port, G3/4" air supply port	10,200

VCML100 / VCML100L

Features and Strengths

- Integrated VMECA Vacuum Cartridge technology
- High vacuum flow to replace motor pump
- Easy maintenance
- Excellent performance in leakage application and in conveying system
- for granules, transferring bulk materials and powder

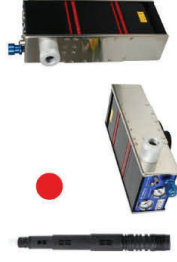

Specifications

Description	VCML100	VCML100L
Max. Vacuum level	-92 kPa	-75 kPa
Open Vacuum flow	1364 NI/min	1,448 NI/min
Max. Feed pressure	7 bar	7 bar
Temperature	-20 ~ 80 °C	-20 ~ 80 °C
Noise level	60 ~ 65 dBA	60 ~ 65 dBA
Weight	5,520 g	5,518 g

Vacuum Flow

Model	Max. vacuum pressure (-kPa)	Feed Pressure (bar)	Vacuum flow (NI/min) at different vacuum levels (-kPa)												
			0	10	20	30	40	50	60	70	80	90			
VCML100	75	2.2	1208	490	352	212	126	114	66	18	-	-	-	-	-
	92	3.0	1352	608	424	256	132	128	88	66	26	7.6	-	-	-
	92	4.0	1364	616	510	376	276	172	93	69	28	8.4	-	-	-
VCML100L	60	4.0	1208	688	440	280	184	112	27	-	-	-	-	-	-
	70	5.0	1376	784	520	328	200	150	92	45	-	-	-	-	-
	75	6.0	1448	828	616	400	208	152	128	88	-	-	-	-	-

Evacuation Time

Model	Feed Pressure (bar)	Air Consumption (NI/min)	Evacuation time in sec / liter to reach different vacuum levels (-kPa)												
			10	20	30	40	50	60	70	80	90				
VCML100	2.2	388	0.005	0.02	0.027	0.08	0.10	0.18	0.40	-	-	-	-	-	-
	3.0	472	0.004	0.018	0.02	0.07	0.09	0.16	0.20	0.30	0.95	-	-	-	-
	4.0	608	0.003	0.01	0.01	0.02	0.05	0.10	0.15	0.25	0.85	-	-	-	-
VCML100L	4.0	280	0.0089	0.023	0.04	0.07	0.09	0.2	-	-	-	-	-	-	-
	5.0	340	0.0057	0.018	0.03	0.063	0.075	0.1	0.2	-	-	-	-	-	-
	6.0	416	0.0053	0.015	0.029	0.052	0.071	0.09	0.15	-	-	-	-	-	-

VCML200 / VCML200L

Features and Strengths

- Integrated VMECA Vacuum Cartridge technology
- High vacuum flow to replace motor pump
- Easy maintenance
- Excellent performance in leakage application and in conveying system
- for granules, transferring bulk materials and powder



Specifications

Description	VCML200	VCML200L
Max. Vacuum level	-92 kPa	-75 kPa
Open Vacuum flow	2,728 NI/min	2,896 NI/min
Max. Feed pressure	7 bar	7 bar
Temperature	-20 ~ 80 °C	-20 ~ 80 °C
Noise level	60 ~ 65 dBA	60 ~ 65 dBA
Weight	5,523 g	5,530 g

Vacuum Flow

Model	Max. vacuum pressure (-kPa)	Feed Pressure (bar)	Vacuum flow (NI/min) at different vacuum levels (-kPa)												
			0	10	20	30	40	50	60	70	80	90			
VCML200	75	2.2	2416	980	704	424	252	228	132	36	-	-	-	-	-
	92	3.0	2704	1216	848	512	264	256	176	132	52	15.2	-	-	-
	92	4.0	2728	1232	1020	752	552	344	186	138	56	16.8	-	-	-
VCML200L	60	4.0	2416	1376	880	560	368	224	54	-	-	-	-	-	-
	70	5.0	2752	1568	1040	656	400	300	184	90	-	-	-	-	-
	75	6.0	2896	1656	1232	800	416	304	256	176	-	-	-	-	-

Evacuation Time

Model	Feed Pressure (bar)	Air Consumption (NI/min)	Evacuation time in sec / liter to reach different vacuum levels (-kPa)												
			10	20	30	40	50	60	70	80	90				
VCML200	2.2	784	0.0029	0.0098	0.0363	0.0413	0.06	0.096	0.21	-	-	-	-	-	-
	3.0	896	0.0024	0.0074	0.0163	0.0325	0.055	0.086	0.121	0.1975	0.481	-	-	-	-
	4.0	1072	0.0023	0.0066	0.01	0.0188	0.0325	0.07	0.1075	0.195	0.473	-	-	-	-
VCML200L	4.0	560	0.0045	0.0115	0.02	0.035	0.045	0.1	-	-	-	-	-	-	-
	5.0	680	0.0029	0.009	0.015	0.0315	0.0375	0.05	0.1	-	-	-	-	-	-
	6.0	832	0.0027	0.0075	0.0145	0.026	0.0355	0.045	0.075	-	-	-	-	-	-

VCML400 / VCML400L

Features and Strengths

- Integrated VMECA Vacuum Cartridge technology
- High vacuum flow to replace motor pump
- Easy maintenance
- Excellent performance in leakage application and in conveying system
- for granules, transferring bulk materials and powder



Specifications

Description	VCML400	VCML400L
Max. Vacuum level	-92 kPa	-75 kPa
Open Vacuum flow	5,456 NI/min	5,792 NI/min
Max. Feed pressure	7 bar	7 bar
Temperature	-20 ~ 80 °C	-20 ~ 80 °C
Noise level	60 ~ 65 dBA	60 ~ 65 dBA
Weight	5,270 g	5,262 g

Vacuum Flow

Model	Max. vacuum (-kPa)	Feed Pressure (bar)	Vacuum flow (NI/min) at different vacuum levels (-kPa)									
			0	10	20	30	40	50	60	70	80	90
VCML400	75	2.2	4832	1960	1408	848	504	456	264	72	-	-
	92	3.0	5408	2432	1696	1024	528	512	352	264	104	30.4
	92	4.0	5456	2464	2040	1504	1104	688	372	276	112	33.6
VCML400L	60	4.0	4832	2752	1760	1120	736	448	108	-	-	-
	70	5.0	5504	3136	2080	1312	800	600	368	180	-	-
	75	6.0	5792	3312	2464	1600	832	608	512	352	-	-

Evacuation Time

Model	Feed Pressure (bar)	Air Consumption (NI/min)	Evacuation time in sec / liter to reach different vacuum levels (-kPa)									
			10	20	30	40	50	60	70	80	90	
VCML400	2.2	1586	0.0014	0.0049	0.0181	0.0206	0.03	0.048	0.105	-	-	-
	3.0	1792	0.0012	0.0037	0.0081	0.0163	0.0275	0.0431	0.0606	0.0988	0.2406	-
	4.0	2144	0.0011	0.0033	0.005	0.0094	0.0163	0.035	0.0538	0.0975	0.2363	-
VCML400L	4.0	1120	0.0022	0.0058	0.01	0.0175	0.0225	0.05	-	-	-	-
	5.0	1360	0.0014	0.0045	0.0075	0.0158	0.0188	0.0250	0.05	-	-	-
	6.0	1664	0.0013	0.0038	0.0073	0.013	0.0178	0.0225	0.0375	-	-	-

Dimensions – Basic Pump

[Unit: mm]

Free flow exhaust duct Type

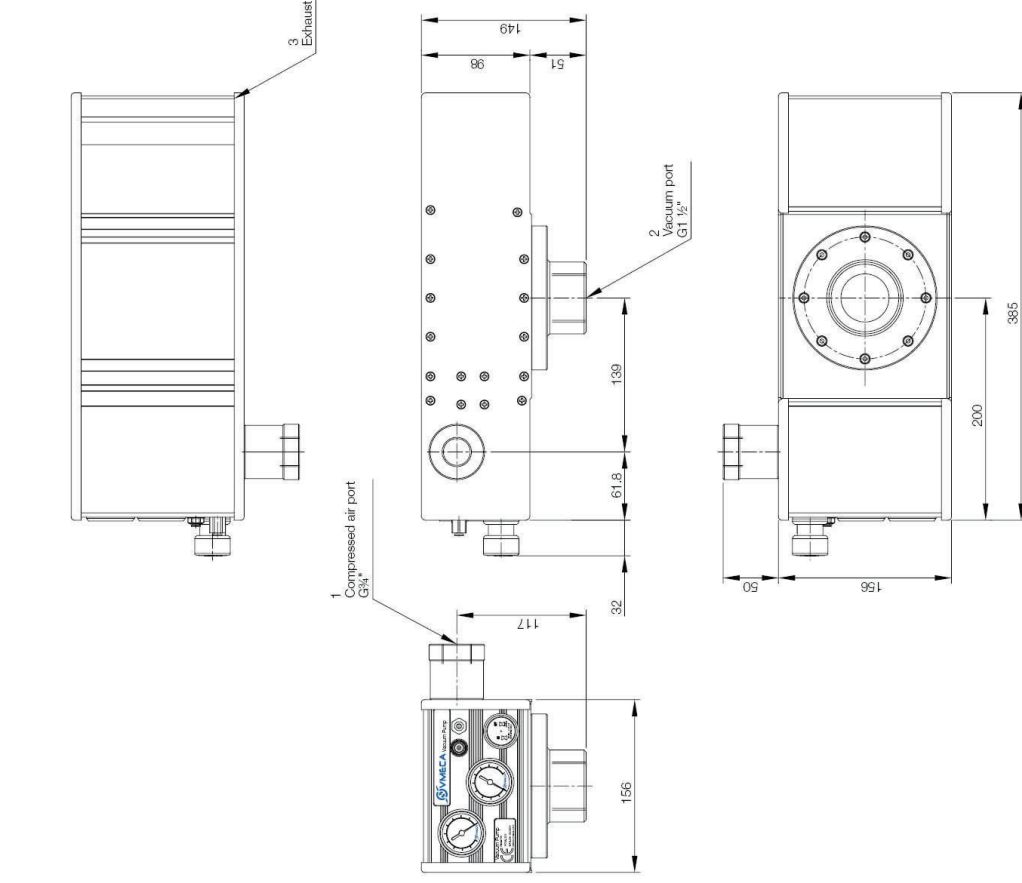

Dimensions – Basic Pump

[Unit: mm]

CP (Concentration port) Type

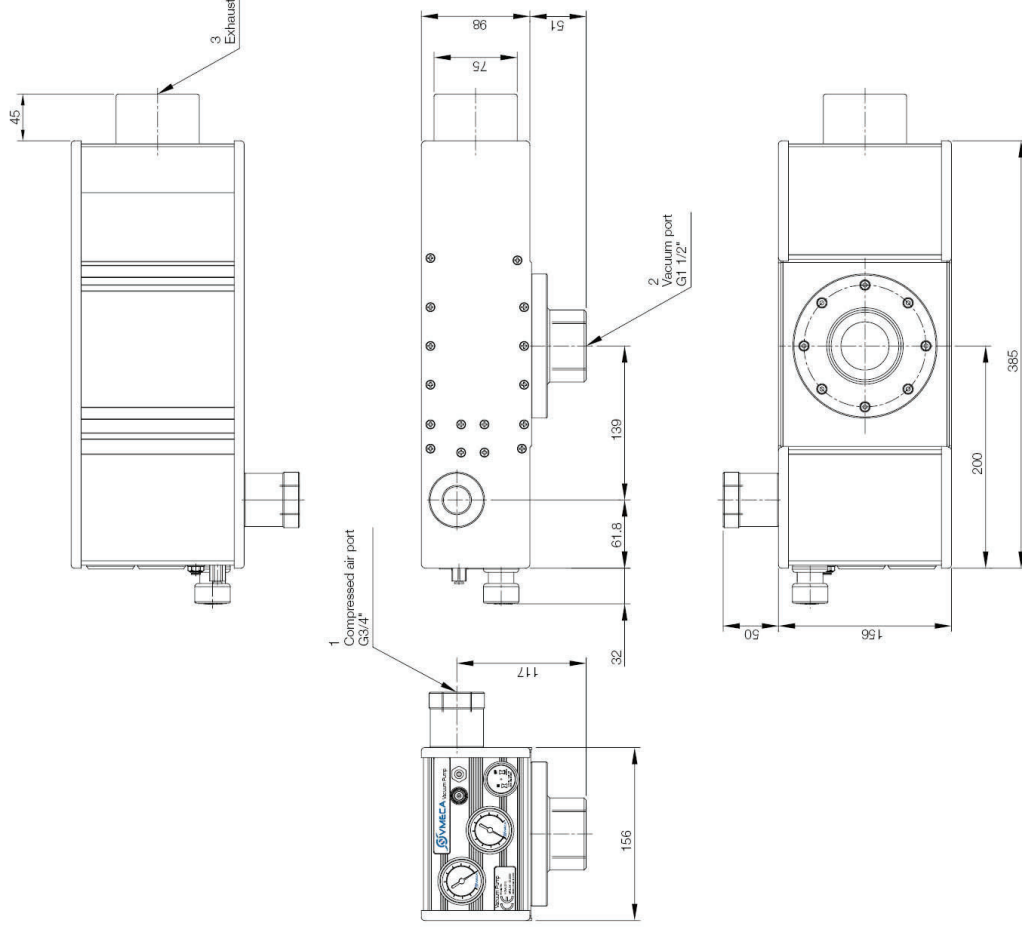

Performance data

VCML100

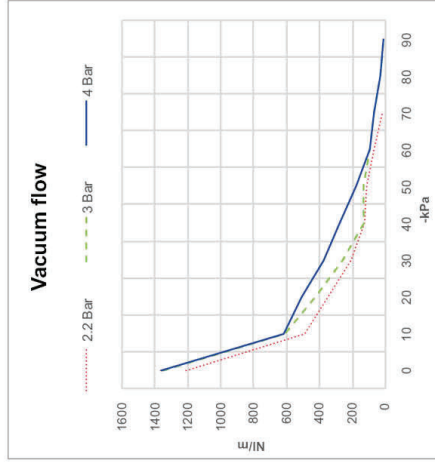

* Vacuum flow at different vacuum level

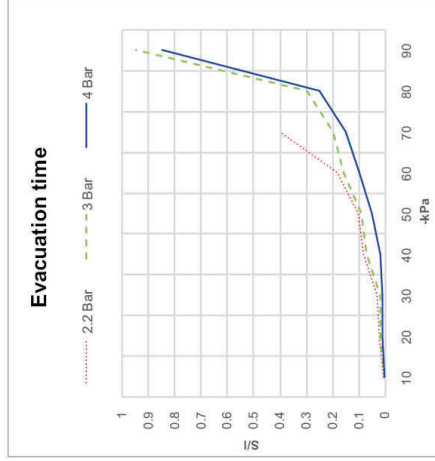

* Time to evacuate a volume at different vacuum level

VCML200

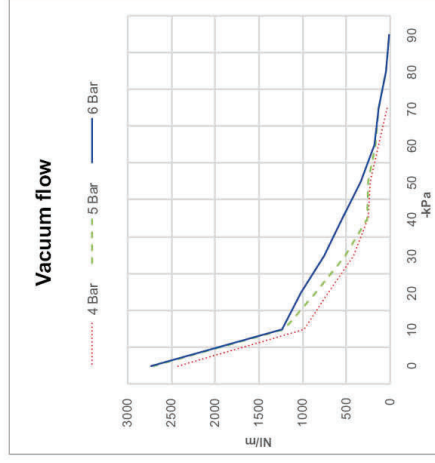

* Vacuum flow at different vacuum level

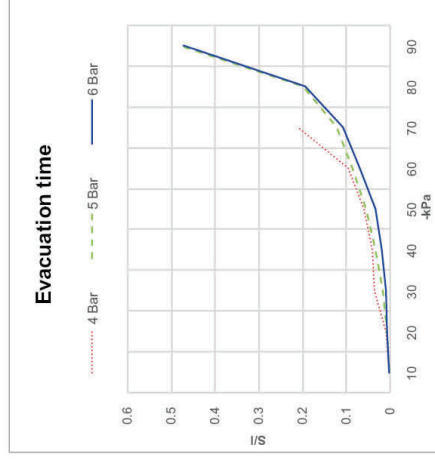

* Time to evacuate a volume at different vacuum level

VCML100L

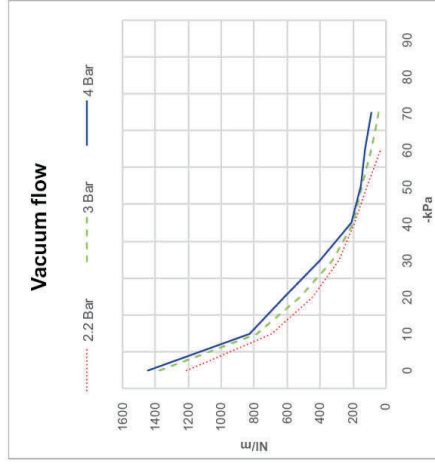

* Vacuum flow at different vacuum level

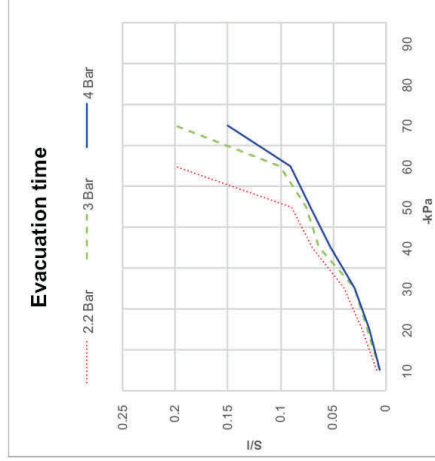

* Time to evacuate a volume at different vacuum level

VCML200L

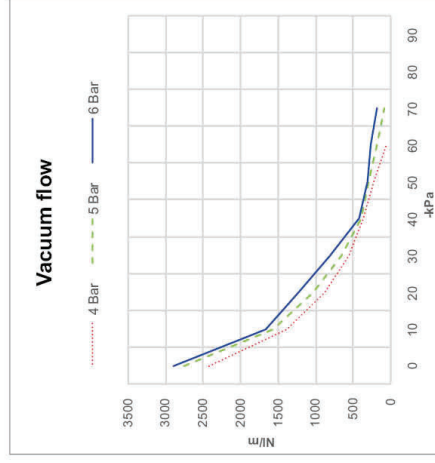

* Vacuum flow at different vacuum level

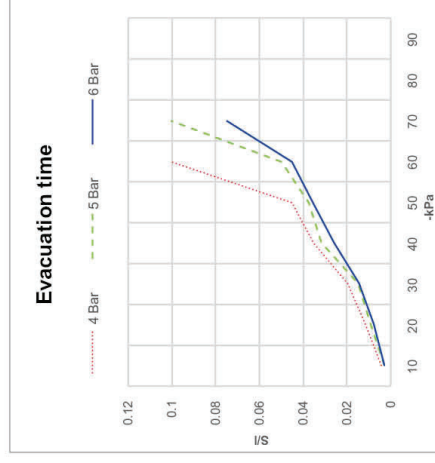

* Time to evacuate a volume at different vacuum level

Performance data

Performance data

Performance data

VCML400

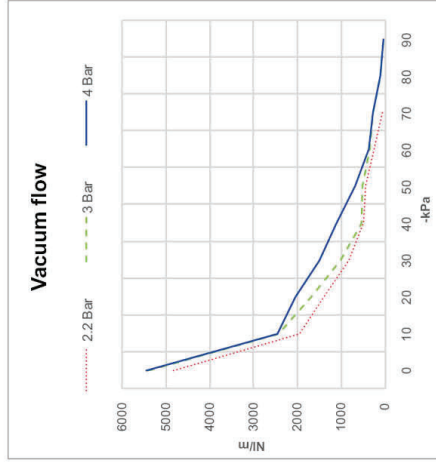

※ Vacuum flow at different vacuum level

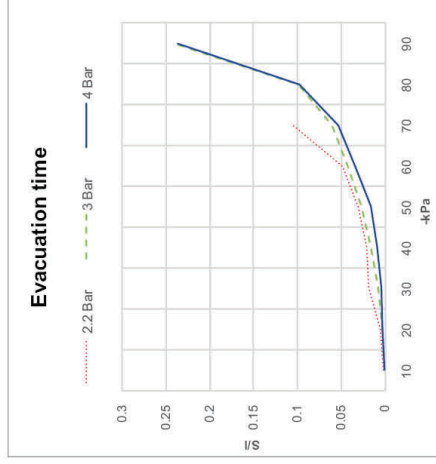

※ Time to evacuate a volume at different vacuum level

VCML400L

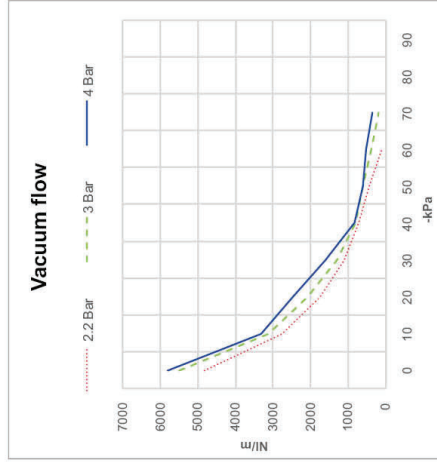

※ Vacuum flow at different vacuum level

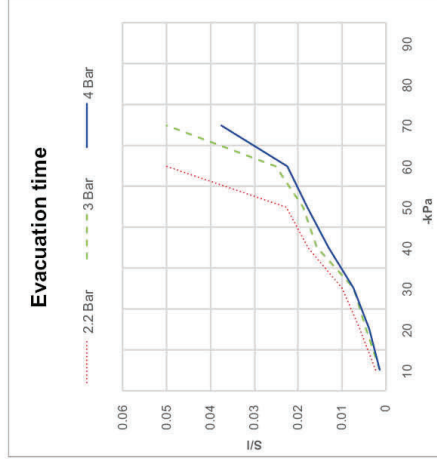

※ Time to evacuate a volume at different vacuum level

Build an Ordering No.

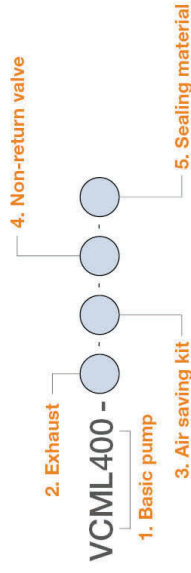

1. Basic pump	Description	Symbol
	VCML Pump, 100 Series, G 1-1/2" Vacuum Port, G 3/4" Air Supply Port	VCML100
	VCML Pump, 200 Series, G 1-1/2" Vacuum Port, G 3/4" Air Supply Port	VCML200
	VCML Pump, 400 Series, G 1-1/2" Vacuum Port, G 3/4" Air Supply Port	VCML400
	VCML Pump "L" cartridge, 100 Series, G 1-1/2" Vacuum Port, G 3/4" Air Supply Port	VCML100L
	VCML Pump "L" cartridge, 200 Series, G 1-1/2" Vacuum Port, G 3/4" Air Supply Port	VCML200L
	VCML Pump "L" cartridge, 400 Series, G 1-1/2" Vacuum Port, G 3/4" Air Supply Port	VCML400L
2. Exhaust	Description	Symbol
	Free flow exhaust duct	No mark
	Concentration port	GP
3. Air saving kit	Description	Symbol
	No air saving kit	Blank
	Air saving kit without air control valve	AS
4. Non-return valve	Description	Symbol
	No non-return valve	Blank
	Non-return valve: No need with Air saving kit	N
5. Sealing material	Description	Symbol
	NBR	Blank
	VITON	V
	EPDM	E

Spare Parts – Basic pumps

Part No.	Description	Weight (g)
VCML100	VCML Pump, Cartridge, 100 Series, G 1-1/2" Vacuum Port, G 3/4" Air Supply Port	5,220
VCML200	VCML Pump, Cartridge, 200 Series, G 1-1/2" Vacuum Port, G 3/4" Air Supply Port	5,234
VCML400	VCML Pump, Cartridge, 400 Series, G 1-1/2" Vacuum Port, G 3/4" Air Supply Port	5,270
VCML100L	VCML Pump, "L" cartridge, 100 Series, G 1-1/2" Vacuum Port, G 3/4" Air Supply Port	5,218
VCML200L	VCML Pump, "L" cartridge, 200 Series, G 1-1/2" Vacuum Port, G 3/4" Air Supply Port	5,230
VCML400L	VCML Pump, "L" cartridge, 400 Series, G 1-1/2" Vacuum Port, G 3/4" Air Supply Port	5,262

Spare Parts – Cartridges

Part No.	Description	Available model
VC303	Midi Vacuum Cartridge, 3-Stage	VCML100, VCML200, VCML400
VCL303	Midi Vacuum Cartridge, "L" Series, 3-Stage	VCML100L, VCML200L, VCML400L